

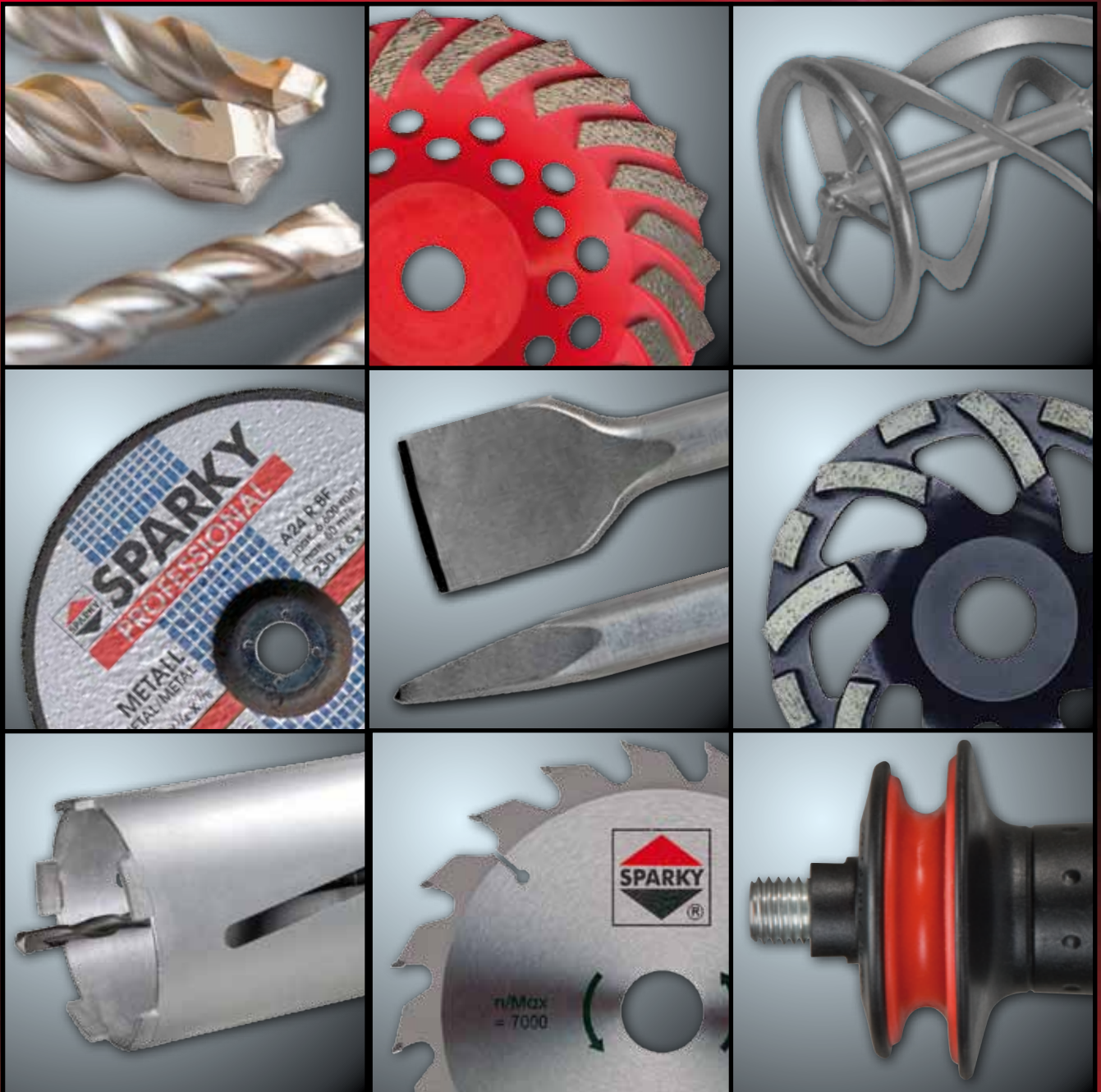

SPARKY

PROFESSIONAL



POWER TOOLS ACCESSORIES

BATTERIES

Compatible with cordless drill/drivers



Note: All batteries should be used with their corresponding battery chargers only.

Cat. №	Voltage/ Capacity	Type	Used with	Pcs/Pack
20009706000	① 12V, 2.0 Ah	NiCd	GUR 12(S), BAR 12E	1
20009700400	② 9.6V, 1.5 Ah	NiCd	BR 9,6E	1
20009700500	③ 12V, 1.5 Ah	NiCd	BR 12E	1
20009700300	④ 12V, 2.0 Ah	NiCd	BR 12E	1
20009700600	⑤ 14.4V, 1.5 Ah	NiCd	BR 15E	1
20009700700	⑥ 14.4V, 2.0 Ah	NiCd	BR 15E	1
20009702000	⑦ 14.4V, 2.0 Ah	NiCd	BUR2 15E	1
20009700800	⑧ 18V, 2.0 Ah	NiCd	BUR2 18E	1
20008706300	⑨ 7.2V, 1.3 Ah	Li-Ion	BR2 7.2Li HD	1
20009705800	⑩ 10.8V, 1.3 Ah	Li-Ion	BR 10.8Li	1
20008707700	⑪ 10.8V, 1.3 Ah	Li-Ion	BR2 10.8Li HD, GUR 10.8Li HD	1
20008706800	⑫ 14.4V, 1.5 Ah	Li-Ion	BR2 15Li HD, BUR2 15Li HD	1
20008706900	⑬ 14.4V, 2.6 Ah	Li-Ion	BR2 15Li HD, BUR2 15Li HD, GUR 15Li HD	1
20008707000	⑭ 14.4V, 3.0 Ah	Li-Ion	BR2 15Li HD, BUR2 15Li HD, GUR 15Li HD	1
20008707100	⑮ 18V, 1.5 Ah	Li-Ion	BUR2 18Li HD	1
20008707200	⑯ 18V, 2.6 Ah	Li-Ion	BUR2 18Li HD	1
20008707300	⑰ 18V, 3.0 Ah	Li-Ion	BUR2 18Li HD	1
20009708200	⑱ 14.4V, 1.3 Ah	Li-Ion	BPR 15Li	1

CHARGERS



Cat. №	Output voltage/current:	Plug type	Used with	Pcs/Pack
20009705900	① 12V / 1.8A	EU	GUR 12(S), BAR 12E	1
20009702100	② 9.6V / 1.5A	EU	BR 9,6E	1
20009702200	③ 12V / 1.5A	EU	BR 12E	1
20009703700	④ 12V / 2A	EU	BR 12E	1
20009702300	⑤ 14.4V / 1.5A	EU	BR 15E	1
20009703800	⑥ 14.4V / 2A	EU	BR 15E, BUR2 15E	1
20009703900	⑦ 18V / 3A	EU	BUR2 18E	1
20009704600	⑧ 5V / 0.3A	EU	GR 3,6Li	1
20009704700	⑨ 9V / 0.7A	EU	GR 7,2Li	1
20009704800	⑩ 14V / 1.4A	EU	BR 10,8Li	1
20008707800	⑪ 12V / 3A	EU	BR2 10,8Li HD, GUR 10,8Li HD	1
20008707400	⑫ 14.4V / 18V	EU	BR2 15Li, HD, BUR2 15Li HD, GUR 15Li HD, BUR2 18Li HD	1
20009708000	⑬ 14.4V	EU	BPR 15Li	1
20008706400	⑭ 7.2V	EU	BR2 7.2Li HD	1
20008706600	⑮ 7.2V	UK	BR2 7.2Li HD	1

BELT HOLSTER



Cat. №	Used with	Pcs/Pack
20009704500	GR 7.2Li, BR 10.8Li, BR 9.6E, BR 12E, BR 10.8Li, BR2 10.8Li HD, GUR 10.8Li HD	1

BITS

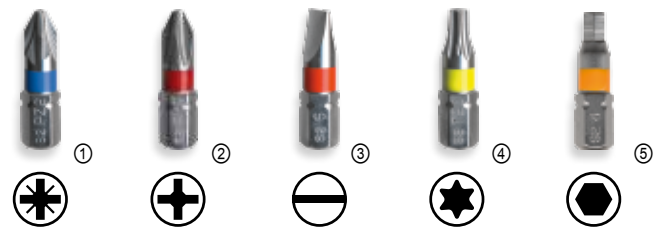
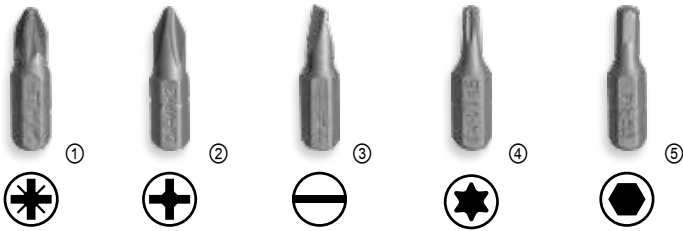

Cat. № (10 pcs)	Cat. № (100 pcs)	Type / Length, mm	Material
SCREWDRIVER BITS – Chrome Vanadium			
Bits Pozidrive			
20009720009	20009720012	PZ 1 / 25	Cr-V
20009720109	20009720112	PZ 2 / 25	Cr-V
20009720209	20009720212	PZ 3 / 25	Cr-V
Bits Phillips			
20009720309	20009720312	PH 1 / 25	Cr-V
20009720409	20009720412	PH 2 / 25	Cr-V
20009720509	20009720512	PH 3 / 25	Cr-V
Bits Slotted			
20009720609	20009720612	SZ 0.6x4.5 / 25	Cr-V
20009720709	20009720712	SZ 0.8x5.5 / 25	Cr-V
20009720809	20009720812	SZ 1.2x6.5 / 25	Cr-V
Bits Torx			
20009720909	20009720912	TX 10 / 25	Cr-V
20009721009	20009721012	TX 15 / 25	Cr-V
20009721109	20009721112	TX 20 / 25	Cr-V
20009721209	20009721212	TX 25 / 25	Cr-V
20009721309	20009721312	TX 30 / 25	Cr-V
Bits Hex			
20009721409	20009721412	HEX 3 / 25	Cr-V
20009721509	20009721512	HEX 4 / 25	Cr-V
20009721609	20009721612	HEX 5 / 25	Cr-V
20009721709	20009721712	HEX 6 / 25	Cr-V

Cat. № (10 pcs)	Cat. № (100 pcs)	Type / Length, mm	Material
SCREWDRIVER BITS – S2 Steel hardened bits for extra durability			
Bits Pozidrive <small>HEAVY DUTY</small>			
20008720009	20008720012	S2 PZ 1 / 25	S2
20008720109	20008720112	S2 PZ 2 / 25	S2
20008720209	20008720212	S2 PZ 3 / 25	S2
Bits Phillips <small>HEAVY DUTY</small>			
20008720309	20008720312	S2 PH 1 / 25	S2
20008720409	20008720412	S2 PH 2 / 25	S2
20008720509	20008720512	S2 PH 3 / 25	S2
Bits Slotted <small>HEAVY DUTY</small>			
20008720609	20008720612	S2 SZ 0.6x4.5 / 25	S2
20008720709	20008720712	S2 SZ 0.8x5.5 / 25	S2
20008720809	20008720812	S2 SZ 1.2x6.5 / 25	S2
Bits Torx <small>HEAVY DUTY</small>			
20008720909	20008720912	S2 TX 10 / 25	S2
20008721009	20008721012	S2 TX 15 / 25	S2
20008721109	20008721112	S2 TX 20 / 25	S2
20008721209	20008721212	S2 TX 25 / 25	S2
20008721309	20008721312	S2 TX 30 / 25	S2
Bits Hex <small>HEAVY DUTY</small>			
20008721409	20008721412	S2 HEX 3 / 25	S2
20008721509	20008721512	S2 HEX 4 / 25	S2
20008721609	20008721612	S2 HEX 5 / 25	S2
20008721709	20008721712	S2 HEX 6 / 25	S2



MAGNETIC HOLDERS		
20009722300	① Magnetic holder (1 pc.)	Cr-V
20008722400	② Fast change magnetic holder (1 pc.) <small>HEAVY DUTY</small>	S2

25 PIECES BIT SET

Contents:

- 3 pcs Hex sockets: 6/8/10 mm
- Compact Screw Guide
- 1x6 mm Hex quick change connector
- Hex to Square adapter: 6 mm x 10 mm;
- 7 pcs Hex screwdriver bits 25mm: P1 x2, P2, P3, 4-6 Slotted, R2
- 6 pcs Hex screwdriver bits 50mm: 4-6 Slotted, 6-8 Slotted, R1, RS, P1, P2
- 6 pcs Hex Titanium coated drill bits: 1.5 mm, 2.0 mm, 2.5 mm, 3.0 mm, 5.0 mm, 6.0 mm
- Storage pouch



Cat. №	Suitable for	Pcs/Pack
20009744314	All cordless drills/ impact drills	25

BIT SETS



SCREWDRIVER BIT SETS		
Bits Pozidrive 10pcs / Magnetic holder		
20009721814	PZ1 – 2 pcs; PZ2 – 5 pcs; PZ3 – 2 pcs; Magnetic holder	Cr-V
Set Bits Torx 10 pcs / Magnetic holder		
20009721914	TX10 – 1 pc; TX15 – 2 pcs; TX20 – 3pcs; TX25 – 2 pcs; TX30 – 1 pc; Magnetic holder	Cr-V
Set Bits Mixed 10 pcs / Magnetic holder		
20009722014	PH1, PH2, PZ1, PZ2, PZ3, TX15, TX20, TX25, SZ 0.8x5.5; Magnetic holder	Cr-V
Set Bits Mixed 10 pcs / Magnetic holder		
20009722114	PZ 2, PZ 3, PH 2, PH 3, SZ 0.8x5.5, SZ 1.2x6.5, TX 15, TX 20, HEX 4, Magnetic holder	Cr-V
Set Bits Mixed S2 – 10 pcs / Fast change magnetic holder <small>HEAVY DUTY</small>		
20008722214	S2-PH1; S2-PH2; S2-PZ1; S2-PZ2; S2 SZ-0.6x4.5; S2 SZ-1.2x6.5; S2-TX15; S2-TX20; S2-TX30; Fast change magnetic holder	S2
Set Bits Mixed 15 pcs / Fast magnetic holder <small>HEAVY DUTY</small>		
20008744414	PH 1; PH 2; PH 3; PZ 1; PZ 2; PZ 3; SZ 4; SZ 5; HEX3; HEX 4; HEX 5; TORX 20; TORX 25; TORX 30;	S2

MASONRY DRILL BITS



Material: Carbon steel, Carbide tip

Cat. №	Diameter x total length, mm	Pcs/Pack
Standard version:		
20009200000	4 x 75	1
20009200600	5 x 85	1
20009200100	6 x 100	1
20009200200	8 x 120	1
20009200300	10 x 120	1
20009200400	12 x 150	1
20009200500	14 x 150	1
20009204100	16 x 150	1
Long version:		
20009200700	5 x 150	1
20009200800	6 x 200	1
20009200900	8 x 200	1
20009201000	10 x 200	1
20009201100	12 x 250	1
20009203100	6 x 400	1
20009203200	8 x 400	1
20009203300	10 x 400	1
20009203400	12 x 400	1
20009203500	14 x 400	1
20009203600	16 x 400	1
HEX shank:		
20009780000	4 x 75	1
20009780100	5 x 85	1
20009780200	6 x 100	1
20009780300	8 x 120	1
20009780400	10 x 120	1
20009780500	12 x 150	1
Pro Series with black finish:		
20009203700	8 x 120	1
20009203800	10 x 120	1
20009203900	12 x 150	1
20009204000	14 x 150	1

DRILL BIT FOR GLASS



Shank material: Carbon steel 45. Tip material: Tungsten Carbide YG6X

Cat. №	Diameter x total length, mm	Pcs/Pack
20009920000	3 x 65	1
20009920100	4 x 65	1
20009920200	5 x 65	1
20009920300	6 x 65	1
20009920400	8 x 70	1
20009920500	10 x 80	1
20009920600	12 x 90	1

METAL DRILL BITS



Material: HSS 9341

Cat. №	Diameter x total length, mm	Pcs/Pack
Standard version:		
20009280401	1.5 x 43	2
20009280501	2.0 x 49	2
20009280601	2.5 x 57	2
20009280701	3.0 x 61	2
20009280801	3.2 x 65	2
20009280901	3.5 x 70	2
20009280000	4.0 x 75	1
20009281000	4.2 x 75	1
20009281100	4.5 x 80	1
20009281200	4.8 x 86	1
20009281300	5.0 x 86	1
20009281400	5.5 x 93	1
20009280100	6.0 x 93	1
20009281500	6.5 x 101	1
20009280200	8.0 x 117	1
20009281600	8.5 x 117	1
20009281700	9.0 x 125	1
20009281800	9.5 x 125	1
20009280300	10.0 x 130	1
20009281900	11.0 x 142	1
20009282000	12.0 x 151	1
20009282100	13.0 x 151	1
Long version, DIN340:		
20009282201	2.0 x 85	2
20009282301	2.5 x 95	2
20009282401	3.0 x 100	2
20009282501	3.2 x 106	2
20009282601	3.5 x 110	2
20009282700	4.0 x 119	1
20009282800	4.2 x 119	1
20009282900	4.5 x 126	1
20009283000	4.8 x 132	1
20009283100	5.0 x 132	1
20009283200	5.5 x 139	1
20009283300	6.0 x 139	1
20009283400	6.5 x 148	1
20009283500	8.0 x 165	1
20009283600	9.0 x 175	1
20009283700	10.0 x 184	1
Cobalt:		
20009284001	2.0 x 49	2
20009284101	2.5 x 57	2
20009284201	3.0 x 61	2
20009284301	3.2 x 65	2
20009284401	3.5 x 70	2
20009284500	4.0 x 75	1
20009284600	4.2 x 75	1
20009284700	4.5 x 80	1
20009284800	4.8 x 86	1
20009284900	5.0 x 86	1
20009285000	5.5 x 93	1
20009285100	6.0 x 93	1
20009285200	6.5 x 101	1
20009285300	8.0 x 117	1
20009285400	8.5 x 117	1
20009285500	9.0 x 125	1
20009285600	10.0 x 133	1

WOOD DRILL BITS



①



②



Material: Carbon steel 45

Cat. №	Diameter x total length, mm	Pcs/Pack
Auger bits: ①		
20009360000	6 x 230	1
20009360100	8 x 230	1
20009360200	10 x 230	1
20009360500	12 x 230	1
20009360600	14 x 460	1
20009360700	16 x 460	1
20009360800	18 x 460	1
20009360900	20 x 460	1
20009361000	22 x 460	1
20009361100	25 x 460	1
20009361200	28 x 460	1
20009361300	30 x 460	1
20009361400	32 x 460	1
20009361500	35 x 460	1
Brad point drill bits: ②		
20009361600	6 x 90	1
20009361700	8 x 110	1
20009361800	10 x 120	1

METAL DRILL BIT SETS



Cat. №	Diameter, mm	Pcs/Pack
For metal, HSS drill bit sets		
20009283814	1.5, 2, 2.5, 3, 3.2, 3.5, 4.0, 4.5, 4.8, 5.0, 5.5, 6, 6.5	13
20009283914	1, 1.5, 2, 2.5, 3, 3.5, 4, 4.5, 5, 5.5, 6, 6.5, 7, 7.5, 8, 8.5, 9, 9.5, 10	19



Cat. №	Diameter, mm	Pcs/Pack
For metal, HSS drill bits, industrial packing		
20009200109	6	10
20009200209	8	10

SPADE BIT SET



Material: Carbon steel 45

Cat. №	Diameter x total length, mm	Pcs/Pack
20009440000	10 x 150	1
20009440200	12 x 150	1
20009440300	14 x 150	1
20009440400	16 x 150	1
20009440500	18 x 150	1
20009440600	20 x 150	1
20009440700	22 x 150	1
20009440100	25 x 150	1
20009440800	30 x 150	1
20009440900	32 x 150	1
20009441000	35 x 150	1
20009441100	40 x 150	1
20009441200	45 x 150	1
20009441300	50 x 150	1
20009441400	55 x 150	1
For wood, spade bit set:		
20009441514	14, 16, 18, 20, 22, 25, 30 mm; extension rod 300 mm, spanner	9
20009441600	Extension rod 300 mm	1

DRILL BIT SETS

①



②



③



Cat. №	Diameter, mm	Pcs/Pack
For concrete, chrome plated, plastic cassette: ①		
20009201214	for concrete, Ø 4, 5, 6, 8, 10	5
For wood, brad point drill bit set, plastic cassette: ②		
20009361914	Ø 4, 5, 6, 8, 10	5
Combined drill bit set, plastic cassette: ③		
20009201314	- for concrete Ø 4, 5, 6, 8, 10 mm; - for metal Ø 2, 3, 4, 5, 6, 8 mm; - for wood Ø 4, 5, 6, 8, 10 mm	16

DIAMOND CORE DRILL SET

Suitable for brick and masonry

Contents:

- Core drill bits:
 - Ø107 x 150 mm
 - Ø52 x 150 mm
 - Ø28 x 300 mm
- Hex adapter Ø12 x 88 mm
- Extension bar Ø25 x 200 mm
- Pilot drill bit Ø10 x 200 mm
- Drift key 8 x 69 mm



Cat. №	Pcs/Pack
20009490014	7

DRILL NIBBLERS

For all standard drills



Cat. №	Type	Pcs/Pack
20009605000	① Drill nibbler NP 1,8	1
20009605100	② Drill nibbler NP 1,8L	1
20009605214	③ Set of dies for NP 1,8 / NP 1,8L	1
20009605300	④ Punch for NP 1,8 – 128 mm	1
20009605400	⑤ Punch for NP 1,8L – 200 mm	1

DIAMOND CORE DRILL BITS

Attention: Only use core drills on machines fitted with a safety clutch!

Cat. №	Type	Size	Pcs/Pack
20009490400	① Core drill	Ø52 x 150 mm	1
20009490300	② Core drill	Ø76 x 150 mm	1
20009490200	③ Core drill	Ø107 x 150 mm	1
20009490100	④ Core drill	Ø127 x 150 mm	1
20009490500	⑤ Extension bar	L=200 mm	1
20009490600	⑥ Pilot drill bit	Ø10 x 200 mm	1
20009491100	⑦ Hex adapter		1



CHUCKS

Cat. №	Type	Chuck capacity	Pcs/Pack
20009480800	① Keyed chuck	1.0–10 mm	1
20009480100	① Keyed chuck	1.5–13 mm	1
20009480200	② Keyed chuck	3.0–16 mm	1
20009480300	③ Keyless chuck	0.8–10 mm	1
20009480400	③ Keyless chuck	1.5–13 mm	1



VICE STAND – CE 60

- Fixing clamp capacity: 53 mm
- Fixing clamp depth: 35 mm
- Jaw width: 76 mm
- Jaw capacity: 58 mm
- Weight: 0.79 kg



Cat. №	Pcs/Pack
20009700900	1

VICE – CE 100

- For stable clamping of the work piece in drill stand SP 43
- Jaw width: 100 mm
- Jaw capacity: 100 mm
- Clamping size: 125 mm
- Weight: 1.5 kg



Cat. №	Pcs/Pack
20009680900	1

DRILL STAND – SP 50

- Bracket capacity: Ø50 mm
- Jaw capacity: 55 mm
- Throat depth: 30 mm
- Weight: 0.5 kg



Cat. №	Pcs/Pack
20009706600	1

DRILL STAND – SP 43

- Stable performance with cast-iron table
- For all drill types with 43 mm attachment journal, weight up to 3kg and power input up to 1010 W
- Operating stroke when drilling: 70 mm
- Distance between the drill bit axis: 125 mm
- Table dimensions: 160x160 mm
- Height: 550 mm
- Weight: 6 kg



Cat. №	Pcs/Pack
20009681000	1

MIXING PADDLES

For paddle mixers **BM 1060E**, **BM 1060CE Plus**, **BM2 1060CE Plus**, **BM 1360CE Plus**, **BM2 1360CE Plus**



Cat. №	Type	Technical data	Pcs/Pack
20009680100	① SM 120x570	Ø120x570 mm, M14 outer thread, Qmax = 30 kg, Mixing direction from the bottom upwards	1
20009680200	② SM 120x570S	Ø120x570 mm, hex shaft S12, Qmax = 30 kg, Mixing direction from the bottom upwards	1
20009680300	③ SM 140x570	Ø140x570 mm, M14 outer thread, Qmax = 40 kg, Mixing direction from the bottom upwards	1
20009680400	④ SM 121x570	Ø120x570 mm, M14 outer thread, Qmax = 40 kg, Parallel mixing action / radial	1
20009680500	⑤ SM 100x600 E2	Ø100x570 mm, M14 outer thread, Qmax = 20kg, Parallel mixing action / radial	1
20009680600	⑥ SM 120x600 E3	Ø120x570 mm, M14 outer thread, Qmax = 30 kg, Parallel mixing action / radial	1
20009681400	⑦ Adapter M14	With inner M14 thread and inner thread 1/2"-20UNF for connection of all standard drills	1
20009680700	⑧ Extension bar	With inner/outer M14 thread for extension (100 mm)	1

SDS-PLUS DRILL BITS, 2 CUTTERS



Material: 40Cr, Carbid tip

Cat. №	Diameter x total length, mm	Pcs/Pack
20009000000	4 x 110	1
20009000900	6 x 110	1
20009001000	8 x 110	1
20009001100	10 x 110	1
20009000100	5 x 160	1
20009000200	6 x 160	1
20009000300	8 x 160	1
20009000400	10 x 160	1
20009000500	12 x 160	1
20009001200	6 x 210	1
20009001300	8 x 210	1
20009001400	10 x 210	1
20009001500	12 x 210	1
20009001600	16 x 210	1
20009005100	6.5 x 260	1
20009001700	8 x 260	1
20009001800	10 x 260	1
20009001900	12 x 260	1
20009002000	12 x 310	1
20009002100	14 x 310	1
20009002200	16 x 310	1
20009002300	18 x 310	1
20009002400	20 x 310	1
20009002500	12 x 350	1
20009002600	16 x 350	1
20009002700	18 x 350	1
20009002800	12 x 460	1
20009002900	14 x 460	1
20009003000	16 x 460	1
20009003100	18 x 460	1
20009003200	20 x 460	1
20009003300	22 x 460	1
20009003400	12 x 600	1
20009003500	14 x 600	1
20009003600	16 x 600	1
20009003700	18 x 600	1
20009003800	20 x 600	1
20009003900	22 x 600	1
20009004000	16 x 800	1
20009004100	18 x 800	1
20009004200	20 x 800	1
20009004300	22 x 800	1
20009004400	18 x 1000	1
20009004500	20 x 1000	1
20009004600	22 x 1000	1

SDS-PLUS DRILL BIT SETS



Cat. №	Diameter x length, mm	Pcs/Pack
Metal box set: ①		
20009004814	5, 6, 8 x 110; 6, 8, 10, 12 x 160	7



Cat. №	Diameter x length, mm	Pcs/Pack
Plastic cassette: ②		
20009004714	6, 8 x 110; 6, 8, 10 x 160	5

SDS-PLUS CHISELS



Material: 40Cr

Cat. №	Type	Width x total length, mm	Pcs/Pack
20009080000	① Point Chisel	250	1
20009080100	② Flat Chisel	20 x 250	1
20009080200	③ Spade Chisel	40 x 250	1
20009080300	④ Grooving Chisel	22 x 250	1
20009080400	⑤ Tile Chisel (angled)	40 x 250	1

KEYED CHUCK WITH SDS-PLUS ADAPTER



Cat. №	Item	Chuck capacity	Used with	Pcs/Pack
20009480700	① Chuck with SDS-plus adapter	1.5–13 mm	All rotary hammers with SDS-plus drill bit connection	1
20009480600	② SDS-plus adapter only	–	Standard chucks	1

SDS-PLUS PREMIUM CHISELS



- High quality SDS-plus chisels produced from toughened steel with microprocessor controlled heat treatment for a long life
- Special-hardened steel and surface handling for efficient chiselling
- For use in concrete, masonry, natural stone

Cat. №	Type	Width x total length, mm	Pcs/Pack
20008080000	① Point Chisel	250	1
20008080100	② Flat Chisel	20 x 250	1
20008080200	③ Spade Chisel	40 x 250	1
20008080300	④ Grooving Chisel	22 x 250	1
20008080400	⑤ Tile Chisel (30° angled)	40 x 250	1

TCT CORE DRILL BITS SDS-PLUS

- Tungsten carbide teeth and thin-wall construction for efficient drilling and reduced drag
- Allowing large holes to be drilled without machine overload
- For masonry, natural stone and limestone
- Use hammer action for faster drilling
- Pilot drill for easy alignment

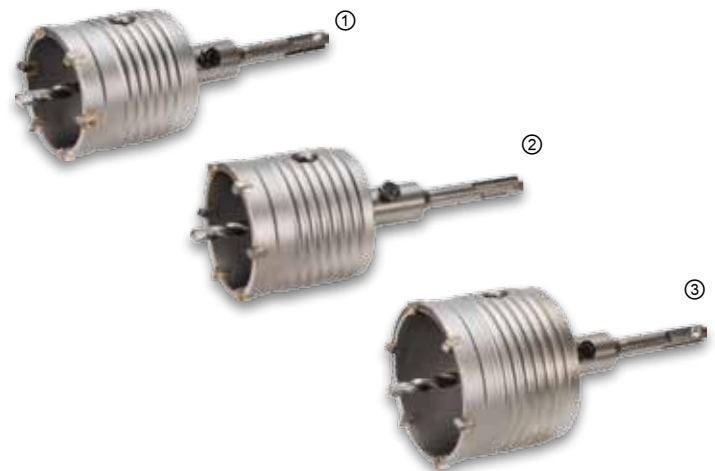

Cat. №	Type	Size	Pcs/Pack
20009490800	① Core drill	Ø65 x 65 mm	1
20009490900	② Core drill	Ø68 x 65 mm	1
20009491000	③ Core drill	Ø80 x 65 mm	1

SDS-MAX CHISELS



Material: 40Cr

Cat. №	Type	Diameter x total length, mm	Pcs/Pack
20009180000	① Point Chisel	250	1
20009180800	① Point Chisel	400	1
20009180100	② Flat Chisel	20 x 250	1
20009180900	② Flat Chisel	25 x 400	1
20009180200	③ Spade Chisel	40 x 250	1
20009181000	③ Spade Chisel	40 x 400	1
20009180300	④ Spade Chisel (angled)	40 x 250	1
20009181100	⑤ Grooving Chisel	25 x 400	1

SDS-MAX PREMIUM CHISELS

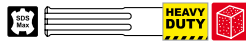

- High quality SDS-max chisels produced from toughened steel with microprocessor controlled heat treatment for a long life
- Special-hardened steel and special surface handling provide for productive operation
- For use in concrete, masonry, natural stone

Cat. №	Type	Diameter x total length, mm	Pcs/Pack
20008181200	① Point Chisel	280	1
20008180800	① Point Chisel	400	1
20008181300	② Flat Chisel	25 x 280	1
20008180900	② Flat Chisel	25 x 400	1
20008180600	③ Spade Chisel (angled)	80 x 300	1
20008180700	④ Grooving Chisel	32 x 300	1

SDS-MAX 4 CUTTER DRILL BITS



- Symmetrical design of the head with main and auxiliary cutters
- Quicker drilling and faster debris removal
- Additional 2 auxiliary cutters protect the drill bit on contacting steel reinforcement
- For use in concrete, masonry, natural stone



Material: 40Cr, Carbid tip

Cat. №	Diameter x total length, mm	Pcs/Pack
20009100600	16 x 370	1
20009100700	18 x 370	1
20009100800	20 x 370	1
20009100900	22 x 370	1
20009101000	28 x 370	1
20009101100	16 x 570	1
20009101200	18 x 570	1
20009101300	20 x 570	1
20009101400	22 x 570	1
20009101500	24 x 570	1
20009101600	28 x 570	1
20009101700	30 x 570	1
20009101800	32 x 570	1
20009101900	34 x 570	1
20009102000	28 x 690	1
20009102100	30 x 690	1
20009102200	35 x 690	1
20009102300	20 x 920	1
20009102400	22 x 920	1
20009102500	25 x 920	1
20009102600	28 x 920	1
20009102700	30 x 920	1
20009102800	32 x 920	1
20009102900	35 x 920	1
20009103000	38 x 920	1
20009103100	40 x 920	1
20009103200	22 x 1320	1
20009103300	25 x 1320	1
20009103400	32 x 1320	1

HAND TROLLEYS

Designed for demolition hammers
K 1640, K 2050, K 3260



Cat. №	Model	Used with	Pcs/Pack
20009701400	① PK 20	K 1640, K 2050	1
20009706200	② PK 32	K 3260	1

DEMOLITION HAMMER ACCESSORIES

Used with **K 512**. Connection type: **17 HEX**

Cat. №	Type	Width x total length, mm	Pcs/Pack
20009461200	① Tine Chisel	280	1
20009461300	② Flat Chisel	25 x 280	1
20009461400	③ Spade Chisel	50 x 280	1
20009461600	④ Groove Chisel	26 x 280	1
20009461714	⑤ 4 pcs. set	280	4
20009461500	⑥ Tine Spade	106 x 500	1

Connection type: **17 HEX**

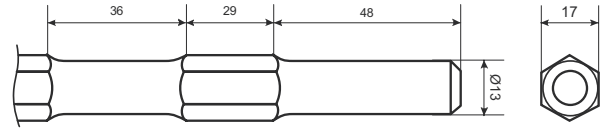

Used with **K 1640**. Connection type: **30 HEX**

Cat. №	Type	Width x total length, mm	Pcs/Pack
20009460000	① Tine Chisel	410	1
20009460100	② Flat Chisel	40 x 410	1
20009460200	③ Spade Chisel	50 x 410	1
20009460300	④ Groove Chisel	410	1
20009460403	⑤ 4 pcs. set	410	4
20009460500	⑥ Tine Spade	135 x 410	1
20009460600	⑦ Square Spade	110 x 410	1
20009460700	⑧ Large flat spade with 30 Hex shank	170 x 150	1
20009460800	⑨ Tamping plate with 30 Hex shank	150 x 150	1
20009460900	⑩ Bush hammer head with 30 Hex shank	60 x 60	1

Connection type: **30 HEX**

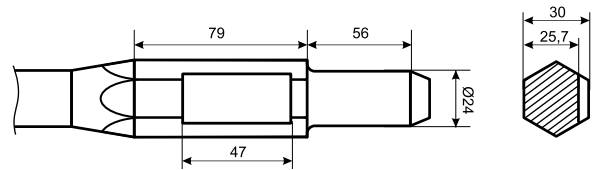

Connection type: **28 HEX**

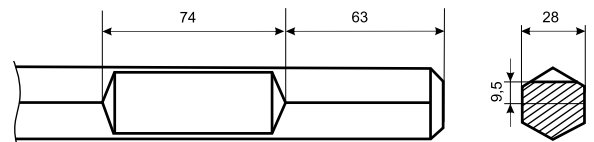

Used with **K 2050** and **K 3260**. Connection type: **28 HEX**

Cat. №	Type	Width x total length, mm	Pcs/Pack
20009465000	① Tine Chisel	410	1
20009465100	② Flat Chisel	35 x 410	1
20009465200	③ Spade Chisel	50 x 410	1
20009465300	④ Groove Chisel	410	1
20009465403	⑤ 4 pcs. set	410	4
20009465500	⑥ Tine Spade	135 x 410	1
20009465600	⑦ Square Spade	110 x 410	1
20009465700	⑧ Large flat spade with 28 Hex shank	170 x 150	1
20009465800	⑨ Tamping plate with 28 Hex shank	150 x 150	1
20009465900	⑩ Bush hammer head with 28 Hex shank	60 x 60	1

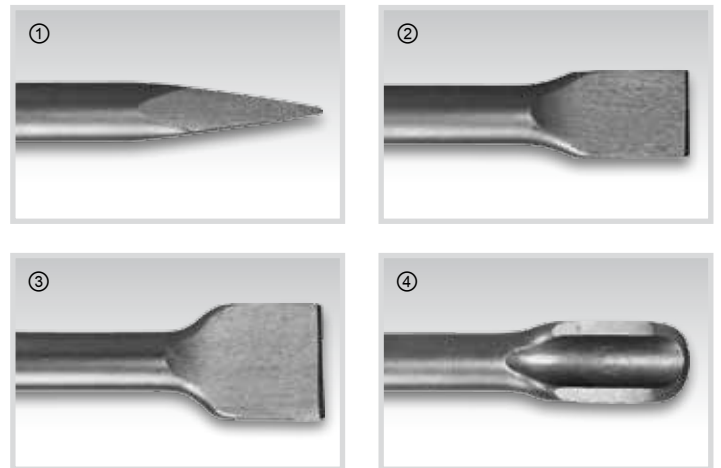

Used with **K 3260**. Connection type: **28 HEX**

Cat. №	Type	Width x total length, mm	Pcs/Pack
20009461000	① Tine chisel	530	1
20009461100	② Flat chisel	35 x 530	1

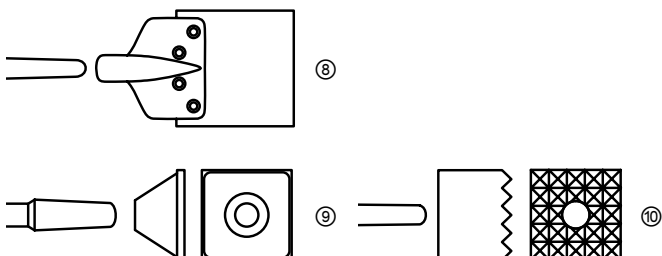

STIRRUP HANDLES



Cat. №	Used with	Pcs/Pack
20009682000	FB 514	1
20009682500	FB 616 / PM 1026CE, PM 1324CE, PM 1631CE PMB 1200CE, PMB 1632, PMB 1655	1
20009682100	FB 722, FB 724, FB 726 / PMB 2030E, PMB 2230E, PMB 2430E	1

SIDE HANDLE



Cat. №	Used with	Pcs/Pack
20009710000	K 615CE	1

ANTI-VIBRATION HANDLES

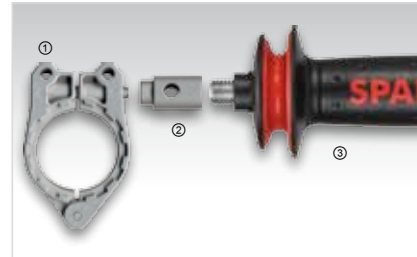

Cat. №	Used with	Pcs/Pack
20009682600	① Steel clamp for BUR 131E; BUR 150E/CET; BU2 160; BUR2 160E; BUR2 200E/201E; BUR2 250E/CET; BUR2 350E/CET; BUR2 355CE; BBK 1100E	1
20009681700	① Aluminium clamp for BPR 220E, BPR 240E, BPR 240CE, BPR 260E, BPR 260CE, BPR 261E, BPR 280CE	1
20009681800	② Extension bar (32.4 mm long) with M14/L12 thread, for BPR 220E, BPR 240E, BPR 240CE, BPR 260E, BPR 260CE, BPR 261E, BPR 280CE	1
20009681600	② Extension bar (50 mm long) with M14/L12 thread	1
20009681900	② Extension bar (100 mm long) with M14/L12 thread	1
20009682200	③ Rotary Hammers BPR 220E, BPR 240E, BPR 240CE, BPR 260E, BPR 260CE, BPR 261E, BPR 280CE; Impact drills with M14/L12 thread; All two-hand angle grinders with M14/L12 thread for side handle	1
20009682300	③ All one-hand angle grinders with M8/L10 thread for side handle	1
20009682400	③ Rotary Hammers BP 330CE, BP 540CE, BP 750CE with M8/L30 thread	1

NON-BURST, ANTI-ROTATION SAFETY GUARDS



FOR GRINDING ▶

Cat. №	Cat. №	HEAVY DUTY	Diameter, mm	Used with	Pcs/Pack
20009683500	20008683500		115	Small range angle grinders	1
20009683600	20008683600		125		1
20009683700	20008683700		125	Medium range angle grinders	1
20009683800	20008683800		150		1
20009683900	20008683900		180	Large range angle grinders	1
20009684000	20008684000		230		1

FOR CUTTING ▶

Cat. №	Cat. №	HEAVY DUTY	Diameter, mm	Used with	Pcs/Pack
20009684100	20008684100		115	Small range angle grinders	1
20009684200	20008684200		125		1
20009684300	20008684300		125	Medium range angle grinders	1
20009684400	20008684400		150		1
20009684500	20008684500		180	Large range angle grinders	1
20009684600	20008684600		230		1

ABRASIVE FLAP DISCS

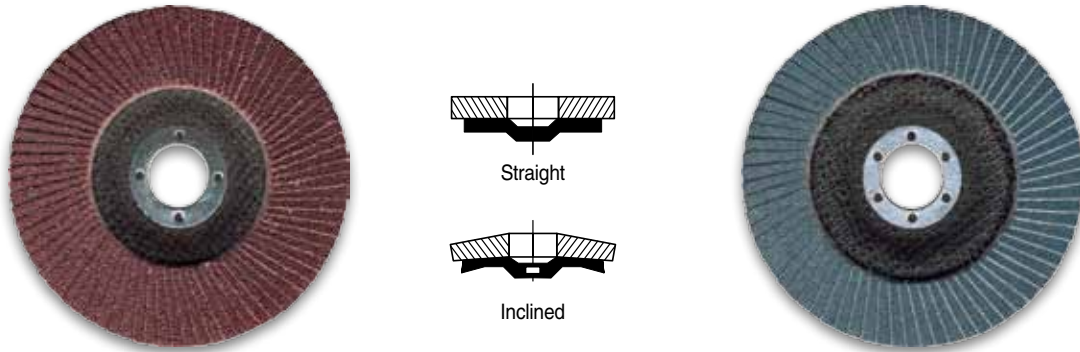

ALUMINIUM OXIDE ① ▶

Cat. №	Diameter x Bore, mm	Grit	Type	Usage	Pcs/Pack
20009578300	100 x 16	40	Straight	For grinding flat surfaces. Most efficient when used at angle of 0°– 45°. Suitable for rough and intermediate grinding for steel, non-ferrous metals, wood and plastics. High lamellar lining on glass fibre plate. Uniform grinding capacity, cool grinding, low noise level, even grinding results. Max. working speed 80 m/s	1
20009578500		60			1
20009578700		80			1
20009578900		120			1
20009571900	115 x 22.23	40	Straight		1
20009572000		60			1
20009572100		80			1
20009572200		120			1
20009572300	125 x 22.23	40	Straight		1
20009572400		60			1
20009572500		80			1
20009572600		120			1
20009572700	150 x 22.23	40	Straight		1
20009572800		60			1
20009572900		80			1
20009573000		120			1
20009573100	180 x 22.23	40	Straight	1	
20009573200		60		1	
20009573300		80		1	
20009573400		120		1	
20009578400	100 x 16	40	Inclined	For contour and edge grinding. Most efficient when used at wider angle of 15°– 25°. Suitable for rough and intermediate grinding for steel, non-ferrous metals, wood and plastics. High lamellar lining on glass fibre plate. Uniform grinding capacity, cool grinding, low noise level, even grinding results. Max. working speed 80 m/s	1
20009578600		60			1
20009578800		80			1
20009579000		120			1
20009573500	115 x 22.23	40	Inclined		1
20009573600		60			1
20009573700		80			1
20009573800		120			1
20009573900	125 x 22.23	40	Inclined		1
20009574000		60			1
20009574100		80			1
20009574200		120			1
20009574300	150 x 22.23	40	Inclined		1
20009574400		60			1
20009574500		80			1
20009574600		120			1
20009574700	180 x 22.23	40	Inclined	1	
20009574800		60		1	
20009574900		80		1	
20009575000		120		1	

ZIRCONIUM OXIDE ② ▶

Cat. №	Diameter x Bore, mm	Grit	Type	Usage	Pcs/Pack
20009579100	100 x 16	40	Straight	For grinding flat surfaces. Most efficient when used at angle of 0°– 45°. Suitable for rough and intermediate grinding in the entire metal industry. High lamellar lining on glass fibre plate. Uniform grinding capacity, cool grinding, low noise level, even grinding results. Max. working speed 80 m/s	1
20009579300		60			1
20009579500		80			1
20009579700		120			1
20009575100	115 x 22.23	40	Straight		1
20009575200		60			1
20009575300		80			1
20009575400		120			1
20009575500	125 x 22.23	40	Straight		1
20009575600		60			1
20009575700		80			1
20009575800		120			1
20009575900	150 x 22.23	40	Straight		1
20009576000		60			1
20009576100		80			1
20009576200		120			1
20009576300	180 x 22.23	40	Straight	1	
20009576400		60		1	
20009576500		80		1	
20009576600		120		1	
20009579200	100 x 16	40	Inclined	For contour and edge grinding. Most efficient when used at wider angle of 15°– 25°. Suitable for rough and intermediate grinding in the entire metal industry. High lamellar lining on glass fibre plate. Uniform grinding capacity, cool grinding, low noise level, even grinding results. Max. working speed 80 m/s	1
20009579400		60			1
20009579600		80			1
20009579800		120			1
20009576700	115 x 22.23	40	Inclined		1
20009576800		60			1
20009576900		80			1
20009577000		120			1
20009577100	125 x 22.23	40	Inclined		1
20009577200		60			1
20009577300		80			1
20009577400		120			1
20009577500	150 x 22.23	40	Inclined		1
20009577600		60			1
20009577700		80			1
20009577800		120			1
20009577900	180 x 22.23	40	Inclined	1	
20009578000		60		1	
20009578100		80		1	
20009578200		120		1	

CARBIDE GRINDING DISC

- Tungsten carbide coated disc for wide range of grinding, sanding and cleaning applications
- Light weight disc with tungsten grain abrasive segments perfect for removal of metal, concrete, marble, epoxy, wood and resins

Cat. №	Diameter, mm	Type	Grit	Pcs/Pack
20009541800	115	Flat	14	1
20009541900	115	Flat	24	1
20009542000	115	Flat	36	1
20009542100	125	Flat	14	1
20009542200	125	Flat	24	1
20009542300	125	Flat	36	1
20009542700	125	Round	14	1
20009542800	125	Round	24	1
20009542900	125	Round	36	1
20009542400	180	Flat	14	1
20009542500	180	Flat	24	1
20009542600	180	Flat	36	1
20009543000	180	Round	14	1
20009543100	180	Round	24	1
20009543200	180	Round	36	1

FLAT ▶



ROUND ▶



ABRASIVE DISCS



CUTTING DISCS METAL ① ▶

Cat. №	Diameter x Width x Bore, mm	Type	Pcs/Pack
20009561709	100 x 1.2 x 16	A30 R BF	10
20009561809	100 x 2.0 x 16	A30 R BF	10
20009561609	100 x 3.0 x 16	A30 S BF	10
20009560009	115 x 3.0 x 22.2	A30 R BF	10
20009560109	125 x 3.0 x 22.2	A30 R BF	10
20009561704	100 x 1.2 x 16	A30 R BF	5
20009561804	100 x 2.0 x 16	A30 R BF	5
20009561604	100 x 3.0 x 16	A30 S BF	5
20009560204	150 x 3.0 x 22.2	A30 R BF	5
20009560304	180 x 3.0 x 22.2	A30 R BF	5
20009560404	230 x 3.0 x 22.2	A30 R BF	5

CUTTING DISCS METAL, DEPRESSED CENTRE ② ▶

Cat. №	Diameter x Width x Bore, mm	Type	Pcs/Pack
20009561509	100 x 3.0 x 16	A30 S BF	10
20009560509	115 x 3.0 x 22.2	A30 R BF	10
20009560609	125 x 3.0 x 22.2	A30 R BF	10
20009561504	100 x 3.0 x 16	A30 S BF	5
20009569004	180 x 3.0 x 22.2	A30 R BF	5
20009560704	230 x 3.0 x 22.2	A30 R BF	5

CUTTING DISCS INOX METAL, THIN ③ ▶

Cat. №	Diameter x Width x Bore, mm	Type	Pcs/Pack
20009561409	100 x 1.0 x 16	WA 60 T BF	10
20009561909	100 x 1.2 x 16	A60 S BF41	10
20009560809	115 x 1.0 x 22.2	A60 S BF41	10
20009560909	115 x 1.2 x 22.2	A60 S BF41	10
20009561009	125 x 1.0 x 22.2	A60 S BF41	10
20009561109	125 x 1.2 x 22.2	A60 S BF41	10
20009561209	180 x 2.0 x 22.2	A36 S BF41	10
20009561309	230 x 2.0 x 22.2	A36 S BF41	10

GRINDING DISCS METAL ④ ▶

Cat. №	Diameter x Width x Bore, mm	Type	Pcs/Pack
20009565504	100 x 6.0 x 16	A24 R BF	5
20009565004	115 x 6.0 x 22.2	A24 R BF	5
20009565104	125 x 6.0 x 22.2	A24 R BF	5
20009565404	150 x 6.0 x 22.2	A24 R BF	5
20009565204	180 x 6.0 x 22.2	A24 R BF	5
20009565304	230 x 6.0 x 22.2	A24 R BF	5

CUTTING DISCS STONE ⑤ ▶

Cat. №	Diameter x Width x Bore, mm	Type	Pcs/Pack
20009563309	100 x 3.0 x 16	C30 S BF	10
20009562509	115 x 3.0 x 22.2	C30 S BF	10
20009562609	125 x 3.0 x 22.2	C30 S BF	10
20009563304	100 x 3.0 x 16	C30 S BF	5
20009562704	150 x 3.0 x 22.2	C30 S BF	5
20009562804	230 x 3.0 x 22.2	C30 S BF	5

CUTTING DISCS STONE, DEPRESSED CENTRE ⑥ ▶

Cat. №	Diameter x Width x Bore, mm	Type	Pcs/Pack
20009563209	100 x 3.0 x 16	C30 S BF	10
20009562909	115 x 3.0 x 22.2	C30 S BF	10
20009563009	125 x 3.0 x 22.2	C30 S BF	10
20009563204	100 x 3.0 x 16	C30 S BF	5
20009563104	230 x 3.0 x 22.2	C30 S BF	5

GRINDING DISCS STONE ⑦ ▶

Cat. №	Diameter x Width x Bore, mm	Type	Pcs/Pack
20009567904	100 x 6.0 x 16	C24 R BF	5
20009567704	125 x 6.0 x 22.2	C24 R BF	5
20009567504	150 x 6.0 x 22.2	C24 R BF	5
20009567604	180 x 6.0 x 22.2	C24 R BF	5
20009567804	230 x 6.0 x 22.2	C24 R BF	5

BENCH GRINDER STAND – SBG 80

Suitable for all SPARKY bench grinders



Cat. №	Operation height	Material	Cat. №
20009701100	85 cm	4 mm sheet steel	1

WHEELS FOR BENCH GRINDERS



WHEELS FOR LIGHT APPLICATIONS ▶

Cat. №	Diameter x Width x Bore, mm	Grit	Used with	Pcs/Pack
20009571000	125 x 16 x 12.7	A36 NV	MBG 125L	1
20009571100	125 x 16 x 12.7	A60 MV	MBG 125L	1
20009571200	150 x 20 x 12.7	A36 NV	MBG 150L	1
20009571300	150 x 20 x 12.7	A60 MV	MBG 150L	1
20009571400	175 x 20 x 16	A36 NV	MBG 175L	1
20009571500	175 x 20 x 16	A60 MV	MBG 175L	1
20009571600	200 x 20 x 16	A36 NV	MBG 200L	1
20009571700	200 x 20 x 16	A60 MV	MBG 200L	1

WHEELS FOR INDUSTRIAL APPLICATIONS ▶

Cat. №	Diameter x Width x Bore, mm	Grit	Used with	Pcs/Pack
20009570100	150 x 32 x 25	A24 PV	MBG 150	1
20009570000	150 x 32 x 25	A36 NV	MBG 150	1
20009570200	150 x 32 x 25	A60 MV	MBG 150	1
20009570400	175 x 32 x 25	A24 PV	MBG 175	1
20009570300	175 x 32 x 25	A36 NV	MBG 175	1
20009570500	175 x 32 x 25	A60 MV	MBG 175	1
20009570700	200 x 32 x 25	A24 PV	MBG 200	1
20009570600	200 x 32 x 25	A36 NV	MBG 200	1
20009570800	200 x 32 x 25	A60 MV	MBG 200	1

SANDING BELT

- Compatible with bench grinders



Cat. №	Size, mm	Grit	Pcs/Pack
20009903402	914 x 100	40	3
20009903502	914 x 100	60	3
20009903602	914 x 100	80	3
20009903702	914 x 100	100	3
20009903802	914 x 100	120	3

DIAMOND CUTTING DISC – Premium Quality

- Super thin diamond cutting disc for cutting tiles, ceramics, marble
- For quick and precise cutting
- Extra durable for extended use



Cat. №	Dimensions, mm	Pcs/Pack
20009543400	115 x 2 x 22.23	1

DIAMOND CUP WHEELS

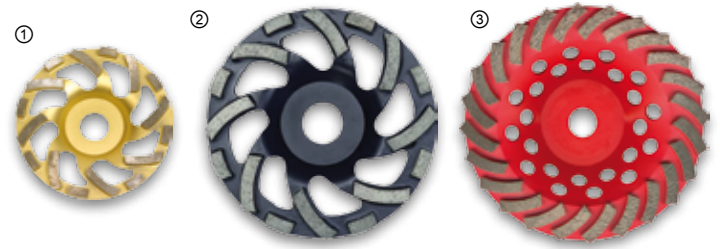

Cat. №	Diam. x Height x Bore, mm	Type	Pcs/Pack
20008540300	127 x 22 x 22.23 (5")	HEAVY DUTY ① TA5 Turbo Gold	1
20008545300	177.8 x 30 x 22.23 (7")	HEAVY DUTY ② TA7 Turbo Schwarz	1
20009545000	127 x 25.4 x 22.23 (5")	③ TA5 Turbo Aggressor	1
20009545100	152.4 x 27 x 22.23 (6")	③ TA6 Turbo Aggressor	1
20009545200	177.8 x 30 x 22.23 (7")	③ TA7 Turbo Aggressor	1

DOUBLE ROW DIAMOND CUP WHEELS

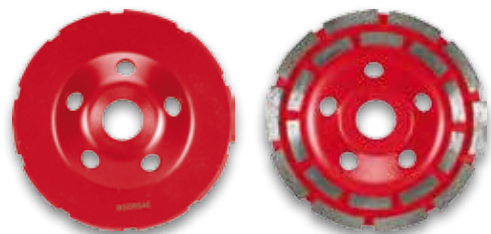

Cat. №	Diameter x Height x Bore, mm	Pcs/Pack
20009545400	152.4 x 27 x 22.23 (6")	1
20009545500	177.8 x 30 x 22.23 (7")	1

DIAMOND BLADES

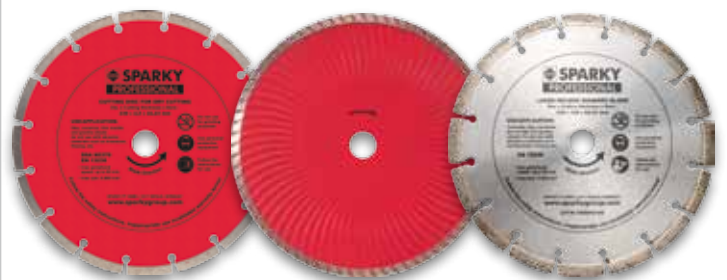

SINTERED DIAMOND BLADES ① ▶

Cat. №	Diameter x Bore, mm	Cutting thickness, mm	Pcs/Pack
20009540000	115 x 22.23	1.8	1
20009540100	125 x 22.23	2.2	1
20009540200	230 x 22.23	2.5	1

CONTINUOUS RIM DIAMOND BLADE ② ▶

Cat. №	Diameter x Bore, mm	Cutting thickness, mm	Pcs/Pack
20009545600	125 x 22.23	2.4	1
20009545700	230 x 22.23	3.0	1

LASER WELDED DIAMOND BLADES ③ ▶

Cat. №	Diameter x Bore, mm	Cutting thickness, mm	Pcs/Pack
20009543300	115 x 22.23	1.8	1
20009541000	125 x 22.23	2.4	1
20009541100	230 x 22.23	2.8	1

DIAMOND GRINDING DISC

- Highly efficient controlled stock removal
- Suitable for all materials
- Light-weight
- Designed for floor preparation, e.g. concrete



Cat. No	Diameter, mm	Grit	Pcs/Pack
20009541200	180	P25	1
20009541300	180	P 50	1
20009541400	180	P100	1
20009541500	180	P150	1
20009541600	180	P200	1

DIAMOND DISC WET

- Highly efficient and resilient disc
- Hook and loop backing
- Specially formulated flexible tools for marble, granite and other hard to polish materials
- Suitable for all type of sanders and polishers

FOR WET SANDING >

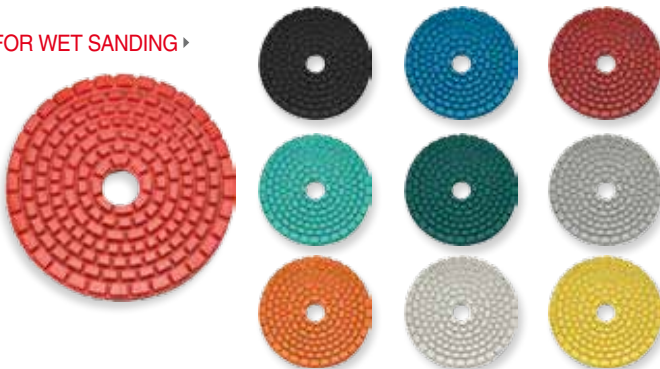

Cat. No	Diameter, mm	Grit	Pcs/Pack
20009594700	100	60	1
20009596600	100	120	1
20009596700	100	200	1
20009595000	100	400	1
20009595200	100	800	1
20009596800	100	1500	1
20009596900	100	3000	1

FOR DRY SANDING >

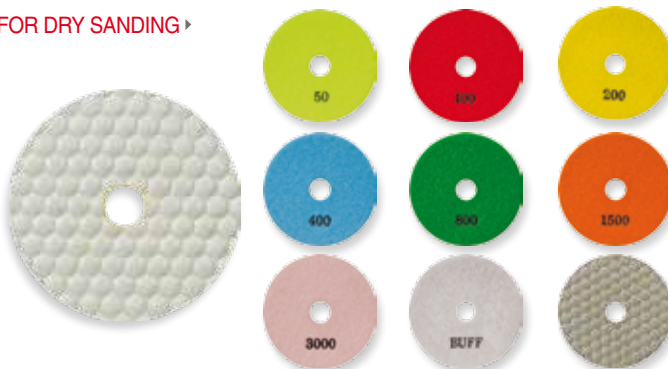

Cat. No	Diameter, mm	Grit	Pcs/Pack
20009904000	100	50	1
20009904100	100	100	1
20009904200	100	200	1
20009904300	100	400	1
20009904400	100	800	1
20009904500	100	1500	1
20009904600	100	3000	1
20009903900	100	BUFF	1
20009806800	100	Flexible backing pad	1

DIAMOND CUP WHEELS

- Quick and efficient removal of thin coatings and lightly abrasive materials, i.e for thermo-plastic coatings, paint coatings, graffiti, thin adhesive
- Reduced weight
- Residues on concrete or screed, rubber coatings



Cat. No	Diameter, mm	Number of teeth	Pcs/Pack
20009543500	125	10	1
20009540400	180	12	1
20009543600	180	14	1
20009541700	180	18	1

ALFABRITE® - SURFACE CONDITIONING DISC

- Hook and loop backing
- Highly efficient abrasive pad for stripping, sanding and surface preparation
- Designed for wet or dry cleaning and removing any residual fine scratches and marks in various materials



Cat. No	Diameter, mm	Grit	Pcs/Pack
20009589202	150	Fine	3
20009589102	150	Medium	3
20009589002	150	Coarse	3
20009594514	150	Set - fine, medium, coarse	3
20009589502	200	Fine	3
20009589402	200	Medium	3
20009589302	200	Coarse	3
20009593014	200	Set - fine, medium, coarse	3
20009593302	225	Fine	3
20009593202	225	Medium	3
20009593102	225	Coarse	3
20009593414	225	Set - fine, medium, coarse	3

FIBRAT® - CLEANING AND FINISHING DISC

- Hook and loop backing
- Highly efficient finishing pad for cleaning, buffing and finishing
- Designed for wet or dry cleaning and finishing of stone, concrete, plaster, wood and metal



Cat. No	Diameter, mm	Grit	Pcs/Pack
20009589802	150	Fine	3
20009589702	150	Medium	3
20009589602	150	Coarse	3
20009592414	150	Set - fine, medium, coarse	3
20009590102	200	Fine	3
20009590002	200	Medium	3
20009589902	200	Coarse	3
20009592514	200	Set - fine, medium, coarse	3
20009592802	225	Fine	3
20009592702	225	Medium	3
20009592602	225	Coarse	3
20009592914	225	Set - fine, medium, coarse	3

SANDING DISCS – ABRANET®

- Hook and loop backing
- Aluminium Oxide
- For effective dust extraction without clogging the disc surface
- Durable and longer-lasting than traditional paper products
- Suitable for all type of sanders and polishers
- For faster stock removal
- For sanding filler, putty, primers, lacquers, composite materials and wood



Cat. №	Diameter, mm	Grit	Pcs/Pack
20009591809	150	P 80	10
20009591909	150	P 100	10
20009592009	150	P 120	10
20009592109	150	P 150	10
20009592209	150	P 180	10
20009592309	150	P 240	10
20009582209	200	P 80	10
20009582309	200	P 100	10
20009582409	200	P 120	10
20009586809	200	P 150	10
20009586909	200	P 180	10
20009587009	200	P 240	10
20009587109	225	P 80	10
20009587209	225	P 100	10
20009587309	225	P 120	10
20009587409	225	P 150	10
20009587509	225	P 180	10
20009587609	225	P 240	10

SANDING DISCS – PUNCHED

- Punched for dust extraction
- Hook and loop backing
- For sanding filler, drywall construction, plaster, wood, primers and paint

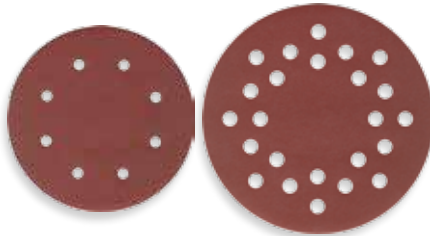

Cat. № (10 pcs)	Cat. № (50 pcs)	Diameter, mm	Grit
20009590609	20009590611	150	P 40
20009590709	20009590711	150	P 60
20009590809	20009590811	150	P 80
20009590909	20009590911	150	P 100
20009591009	20009591011	150	P 120
20009591109	20009591111	150	P 150
20009591209	20009591211	150	P 180
20009591309	20009591311	150	P 220
20009591409	20009591411	200	P 40
20009591509	20009591511	200	P 60
20009584209	20009584211	200	P 80
20009584309	20009584311	200	P 100
20009584409	20009584411	200	P 120
20009584509	20009584511	200	P 150
20009584609	20009584611	200	P 180
20009584709	20009584711	200	P 220
20009591609	20009591611	225	P 40
20009591709	20009591711	225	P 60
20009584809	20009584811	225	P 80
20009584909	20009584911	225	P 100
20009585609	20009585611	225	P 120
20009585709	20009585711	225	P 150
20009585809	20009585811	225	P 180
20009585909	20009585911	225	P 220

JÖST® FINISHING PAD

- Hook and loop backing
- Unique construction offers first class finish for wet and dry sanding and finishing
- Suitable for all type of sanders and polishers
- Allows continuous dust extraction over the entire pad surface
- For effective dust extraction without clogging the disc surface and aiding suction to work surface

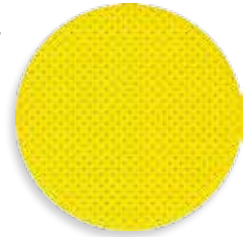

Cat. №	Diameter, mm	Grit	Pcs/Pack
20009582509	200	P 40	10
20009582609	200	P 60	10
20009582709	200	P 80	10
20009582809	200	P 100	10
20009582909	200	P 120	10
20009583009	200	P 150	10
20009583109	200	P 180	10
20009583209	200	P 220	10
20009586009	225	P 40	10
20009586109	225	P 60	10
20009586209	225	P 80	10
20009586309	225	P 100	10
20009586409	225	P 120	10
20009586509	225	P 150	10
20009586609	225	P 180	10
20009586709	225	P 220	10

POLISHING PAD

- Hook and loop backing
- For buffing and final polishing
- Use with support pad



Cat. №	Diameter, mm	Pcs/Pack
20009584000	125	1
20009800400	160	1

COMPACT POLISHING / CLEANING DISCS



Cat. №	Diameter x width, mm	Grit	Application	Pcs/Pack
20009801600	115x3x22,23	Fine	Polishing	1
20009801700	115x3x22,23	Medium	Burnishing	1
20009801800	115x3x22,23	Fibrax	Cleaning/ Polishing	1

FLEXIBLE BACKING PADS

- Compatible with polishers / sanders
- Use with hook and loop accessories



Cat. №	Diameter mm	Thread	Pcs/Pack
20009806800	100	M14	1
20009805000	150	M14	1
20009805100	180	M14	1

LAMBS WOOL POLISHING BONNET

- For buffing and final polishing
- Use with support pad



Cat. №	Diameter, mm	Pcs/Pack
20009801900	160	1
20009800300	200	1

BACKING PAD

- Extra thin, light-weight backing pad with 8 mm bore
- For hook and loop accessories



Cat. №	Diameter, mm	Pcs/Pack
20009806500	100	1
20009806600	115	1
20009806700	150	1

SAFETY GUARD ①

- With dust extraction port diameter 36 mm
- Complete with dust protection brush ring



Cat. №	Diameter, mm	Pcs/Pack
20009685500	200	1
20009685600	225	1

BASE PLATE ②

- Hook and loop backing
- For fixing of flexible backing pads on the sanding head
- Suitable for all SPARKY drywall sanders and polishers with sanding diameter 200 and 225 mm

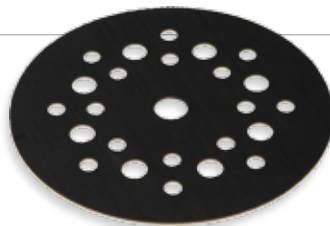

Cat. №	Diameter, mm	Pcs/Pack
20009801500	190	1

POLISHING SUPPORT PAD ③

- Hook and loop backing
- Adapter for polishing bonnets and foam pads
- Suitable for all SPARKY drywall sanders and polishers



Cat. №	Diameter, mm	Pcs/Pack
20009806300	195	1
20009806400	215	1

POLISHING FOAM PAD

- Hook and loop backing
- Hard wearing, medium density pad for polishing and compound applications
- Use with support pad



Cat. №	Diameter, mm	Pcs/Pack
20009800600	200	1

FLEXIBLE BACKING PAD

- Hook and loop backing
- Adapter for all types of hook and loop accessories
- Suitable for all SPARKY drywall sanders



Cat. №	Diameter, mm	Pcs/Pack
20009801300	200	1
20009801400	225	1



BACKING PLATE

- Ultra-thin, light-weight glass-fibre backing pad for hook and loop accessories



Cat. №	Diameter, mm	Pcs/Pack
20009806100	240	1
20009806200	320	1

SPONGE DISC

- Large surface finishing sponge for final finishing of traditional thin-coat gypsum, plaster, lime and cement based renders
- For wet and dry application
- Suitable for variable speed machines
- Hook and loop backing



Cat. №	Diameter, mm	Pcs/Pack
20009800700	200	1
20009800800	250	1
20009800900	350	1

- High quality, light weight and extra durable geranio finishing sponge



Cat. №	Diameter, mm	Pcs/Pack
20009801000	200	1
20009801100	250	1
20009801200	350	1

WATER FEED PRESSURE PUMP

- 10l capacity
- Working pressure 6 bar
- 3.5 m pressure hose
- 1/2" hose connector c/w auto stop



Cat. №	Pcs/Pack
20009890200	1

WATER FEED SYSTEM

- Quick connection 1/2"
- Pressure hose 4 m with water feed control switch
- Water nozzle

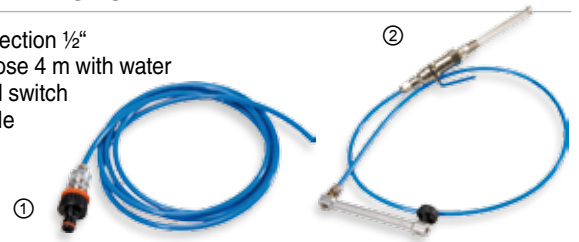

Cat. №	Description	Pcs/Pack
20009890000	① For long reach machines	1
20009890100	② For short reach machines	1

SUCTION HOSE

- 4 m flexible hose with 35 mm adapter



Cat. №	Internal diameter, mm	Pcs/Pack
20009643599	32	1

ADDITIONAL REAR HANDLE

- For extended reach to high walls and ceilings
- Easy assembly
- Complete with 4 fixing screws and washers

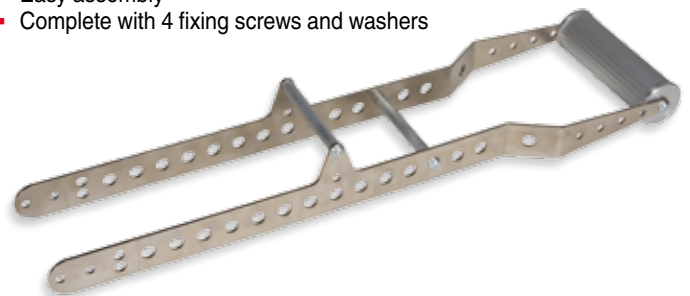

Cat. №	Handle length, mm	Pcs/Pack
20009685200	350	1
20009685300	500	1

MULTI-POSITION HANDLE

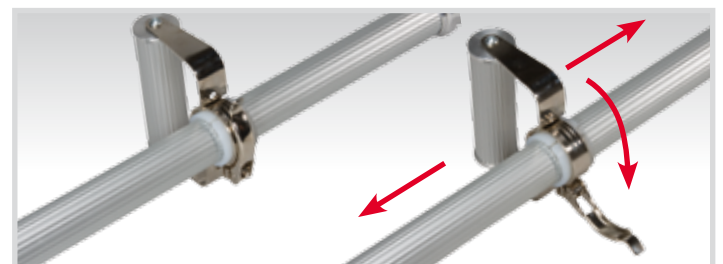

- Toolfree multi-position side handle for long reach sander

Cat. №	Pcs/Pack
20009685400	1

ROTARY CLEANING BRUSH

- Suitable for wet and dry cleaning and polishing of all types of surfaces including paving slabs, brickwork, flooring and decking
- Unique M14 attachment suitable for use with all grinders and polishers



Cat. No	Diameter, mm	Brush material	Applications	Pcs/Pack
20009850200	200	① Tynex, grit 46	Abrasive bristles for cleaning scrubbing and removal of graffiti etc	1
20009850300	200	② Tynex, grit 60	Abrasive bristles for cleaning & smoothing	1
20009850400	200	③ Steel	Abrasive bristles for scouring scrubbing & cleaning	1
20009850500	200	④ Polypropylene	Non abrasive bristles for washing, dusting and polishing	1
20009850600	200	⑤ Tampico (natural fibre)	Non abrasive, soft bristles for washing, dusting, brushing and polishing	1

FLAP WHEEL SANDING

Suitable for use with high torque straight grinder MKL 755CE

- Attachment M14 / Bore 19.2 mm
- Sanding fleece flap for dulling and finishing metal.
- Removes small scratches on metal, hard plastics and wood.
- For decorative texturing of metal



Cat. No	Diameter x width, mm	Grit	Application	Pcs/Pack
20009870000	100 x 110	Coarse	Burnishing	1
20009870100	100 x 110	Medium	Burnishing	1
20009870200	100 x 110	Fine	Burnishing	1
20009870300	100 x 110	Coarse	Polishing	1
20009870400	100 x 110	Medium	Polishing	1
20009870500	100 x 110	Fine	Polishing	1

FLAP WHEEL

Suitable for use with straight grinder MK 550E, MKL 550E, MKL 710CE

- Flexible flap type sanding wheels for cleaning, polishing and sanding
- Achieves effective surface finishes on all types of metal.
- Ideal for cleaning, oxidized coatings and smoothing plastic and wood



Cat. No	Diameter x width, mm	Grit	Application	Pcs/Pack
20009870700	60 x 30	Fine	Burnishing	1
20009870600	60 x 30	Medium	Burnishing	1
20009870900	60 x 30	Fine	Polishing	1
20009870800	60 x 30	Medium	Polishing	1

POLISHING BRUSHES

Suitable for use with high torque straight grinder MKL 755CE

- For deburring, cleaning, roughening and smoothing for metal, wood and hard plastics
- Attachment M 14 / Bore 19.2 mm



Cat. No	Diameter x width, mm	Material type	Pcs/Pack
20009851000	55x110	Steel	1
20009851100	55x110	Nylon	1
20009851200	55x110	Tampico (natural fibre)	1
20009850700	100x110	Steel	1
20009850800	100x110	Nylon	1
20009850900	100x110	Tampico (natural fibre)	1

ADAPTER

- Universal adapter for all Angle Grinders with spindle thread M14 to 6/8 mm tool holder.



Cat. No	Pcs/Pack
20009709314	4

SANDING DISCS

Compatible with random orbit sander EX 125E, EX 150E and EX 150CE with hook-and-loop fixing

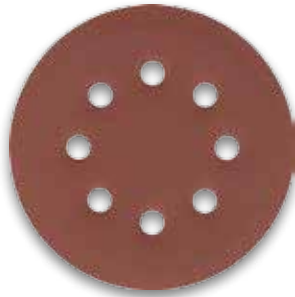

Hook-and-loop fixing for convenience

Cat. №	Grit	Diameter, mm	Pcs/Pack
20009580304	P40	125	5
20009580404	P60	125	5
20009580004	P80	125	5
20009580504	P100	125	5
20009580604	P120	125	5
20009580104	P180	125	5
20009580204	P320	125	5
20009590609	P40	150	10
20009590709	P60	150	10
20009590809	P80	150	10
20009590909	P100	150	10
20009591009	P120	150	10
20009591209	P180	150	10
20009905009	P320	150	10

PADS

Compatible with Multi Sander MP 251 and random orbit sanders EX 125E, EX 150E and EX 150CE with hook-and-loop fixing

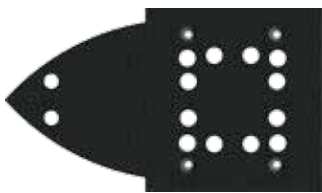

①

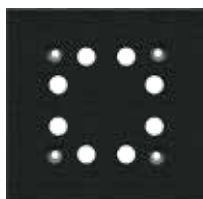

③

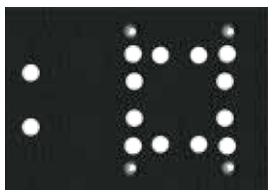

②



④

Cat. №	Type	Size, mm	Pcs/Pack
20009802300	①	199x115x111	1
20009802100	②	165x115	1
20009802200	③	115x111	1
20009710100	④	Ø 125	1
20009710200	④	Ø 150	1

SANDING SHEETS

Compatible with Multi Sander MP 251

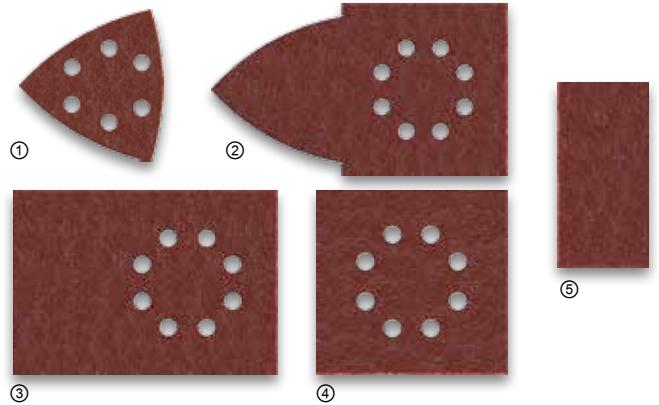

Cat. №	Type	Grit	Diameter, mm	Pcs/Pack
20009902604	①	P40	3x93,3	5
20009902704		P60	3x93,3	5
20009902804		P80	3x93,3	5
20009902904		P100	3x93,3	5
20009903004		P120	3x93,3	5
20009903104		P150	3x93,3	5
20009903204		P180	3x93,3	5
20009903304		P240	3x93,3	5
20009904904		P320	3x93,3	5
20009900204		②	P40	199x111x115
20009900304	P60		199x111x115	5
20009900404	P80		199x111x115	5
20009900504	P100		199x111x115	5
20009900604	P120		199x111x115	5
20009900704	P150		199x111x115	5
20009900804	P180		199x111x115	5
20009900904	P240		199x111x115	5
20009599304	P320		199x111x115	5
20009901004	③		P40	165x115
20009901104		P60	165x115	5
20009901204		P80	165x115	5
20009901304		P100	165x115	5
20009901404		P120	165x115	5
20009901504		P150	165x115	5
20009901604		P180	165x115	5
20009901704		P240	165x115	5
20009904704		P320	165x115	5
20009599404		④	P40	111x115
20009599504	P60		111x115	5
20009599604	P80		111x115	5
20009599704	P100		111x115	5
20009599804	P120		111x115	5
20009599904	P150		111x115	5
20009900004	P180		111x115	5
20009900104	P240		111x115	5
20009599204	P320		111x115	5
20009901804	⑤		P40	115x56,5
20009901904		P60	115x56,5	5
20009902004		P80	115x56,5	5
20009902104		P100	115x56,5	5
20009902204		P120	115x56,5	5
20009902304		P150	115x56,5	5
20009902404		P180	115x56,5	5
20009902504		P240	115x56,5	5
20009904804		P320	115x56,5	5

Set of 3 sanding sheets of five forms (1,2,3,4,5), 15 pcs/pack.

Cat. №	Grit	Pcs/Pack
20009598514	P40	15
20009598614	P60	15
20009598714	P80	15
20009598014	P100	15
20009598114	P120	15
20009598214	P150	15
20009598314	P180	15
20009598414	P240	15
20009599114	P320	15

SANDING BELTS

Compatible with belt sanders MBS 876, MBS 876E, MBS 976, MBS 976E



Cat. №	Grit	Dimensions, mm	Pcs/Pack
20009585002	P40	76 x 533	3
20009585102	P60	76 x 533	3
20009585202	P80	76 x 533	3
20009585302	P100	76 x 533	3
20009585402	P120	76 x 533	3
20009585502	P40 / P80 / P120	76 x 533	3

NIBBLER ACCESSORIES



Cat. №	Description	Used with	Pcs/Pack
20009605614	① Punch and die set	BN 503	1
20009605714	② Punch and die set	BN 604	1
20009605514	③ Punch and die set	BN 502	1

PLANER BLADES

Compatible with P 160, P 282, P 382, P 3110, P 3180

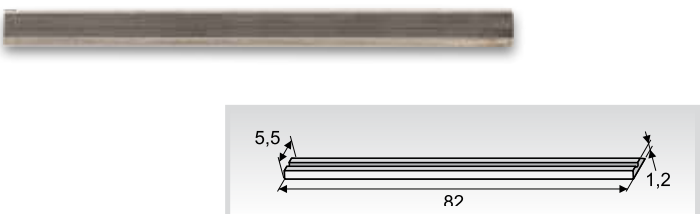

BELT SANDER ACCESSORIES

Compatible with belt sanders MBS 976, MBS 976E



Cat. №	Description	Pcs/Pack
20009701014	Anti slip mat, inversion clamps 2pcs, Sanding frame	5

CHAIN SAW ACCESSORIES



Cat. №	Material	Used with	Pcs/Pack
20009660200	Chain 3/8" x 1.3 mm, 54 teeth	TV 3840	1
20009660800	Chain 3/8" x 1.3 mm, 54 teeth	TV 4240	1
20009660300	Chain 3/8" x 1.3 mm, 72 teeth	TV 5545	1
20009661400	Chain 3/8 x 1.27 mm, 52 teeth	TV 1835	1
20009661600	Chain 3/8 x 1.27 mm, 57 teeth	TV 2040	1
20009661800	Chain 3/8 x 1.27 mm, 62 teeth	TV 2245	1
20009660900	Chain 3/8 x 1.27 mm, 54 teeth	TV 3540	1
20009661000	Chain 3/8 x 1.27 mm, 54 teeth	TV 4040	1
20009661300	Guide bar 35 cm	TV 1835	1
20009661500	Guide bar 40 cm	TV 2040	1
20009660700	Guide bar 40 cm	TV 3840	1
20009660500	Guide bar 40 cm	TV 4240	1
20009661100	Guide bar 40 cm	TV 3540	1
20009661200	Guide bar 40 cm	TV 4040	1
20009661700	Guide bar 45 cm	TV 2245	1
20009660600	Guide bar 45 cm	TV 5545	1

Cat. №	Material	Length, mm	Used with	Pcs/Pack
20009625601	HSS	60	P160	2
20008625601	TCT HEAVY DUTY	60	P160	2
20009625201	HSS	82	P282	2
20008625201	TCT HEAVY DUTY	82	P282	2
20009625002	HSS	82	P382	3
20008625002	TCT HEAVY DUTY	82	P382	3
20009625702	HSS	110	P3110	3
20008625702	TCT HEAVY DUTY	110	P3110	3
20009625402	Mn 65	180	P3180	3

JIG SAW BLADES FOR METAL

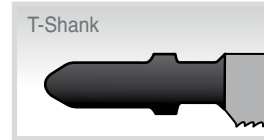
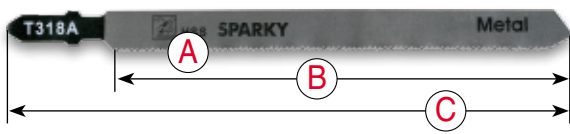

Material: HSS

Cat. №	Type	Tooth spacing (A) x Cutting length (B) x Total length(C), mm	Shank Type	Purpose	Pcs/Pack
2000950004	T118A	1.2 x 50 x 76	T-Shank	Straight cutting in thin materials, ideal for thin sheet metals, non-ferrous metals, aluminium	5
20009502602	U118A	1.2 x 50 x 76	U-Shank	Straight cutting in thin materials, ideal for thin sheet metals, non-ferrous metals, aluminium	3
20009500104	T118B	2 x 50 x 76	T-Shank	Straight cutting in thick materials, ideal for thick sheet metals, non-ferrous metals, aluminium	5
20009500204	T118G	0.8 x 50 x 76	T-Shank	Straight cutting in very thin materials, ideal for very thin sheet metals, non-ferrous metals, aluminium	5
20009502702	U118G	0.8 x 50 x 76	U-Shank	Straight cutting in very thin materials, ideal for very thin sheet metals, non-ferrous metals, aluminium	3
20009500304	T318A	1.2 x 110 x 132	T-Shank	Straight cutting in materials with fillings, non-ferrous metals, aluminium	5
20009502402	U318A	1.2 x 110 x 132	U-Shank	Straight cutting in materials with fillings, non-ferrous metals, aluminium	3
20009500404	T127D	3 x 75 x 100	T-Shank	Straight cutting in aluminium, non-ferrous metals, fibreglass reinforced plastics	5
20009502802	U127D	3 x 75 x 100	U-Shank	Straight cutting in aluminium, non-ferrous metals, fibreglass reinforced plastics	3
20009500504	T227D	3 x 75 x 100	T-Shank	Curved cutting in aluminium, non-ferrous metals, fibreglass reinforced plastics	5
20009500604	T318B	2 x 100 x 132	T-Shank	Straight and curved cutting in metal, non-ferrous metal and aluminium	5

JIG SAW BLADES FOR WOOD

Material: HCS

Cat. №	Type	Tooth space (A) x cutting length (B) x total length (C), mm	Shank	Purpose	Pcs/Pack
20009505004	T101B	2.5 x 75 x 100	T-Shank	Clean and precise cutting, ideal for hardwood, softwood, laminated boards, fibre boards and plastics	5
20009502502	U101B	2.5 x 75 x 100	U-Shank	Clean and precise cutting, ideal for hardwood, softwood, laminated boards, fibre boards and plastics	3
20009505104	T101D	4 x 75 x 100	T-Shank	Clean and precise cutting, ideal for hardwood, softwood, laminated boards, fibre boards and plastics	5
20009505204	T111C	3 x 75 x 100	T-Shank	Fast and straight cutting, ideal for hardwood, softwood and plastics	5
20009505304	T144D	4 x 75 x 100	T-Shank	Fast and straight cutting, ideal for hardwood, softwood and laminated boards	5
20009502902	U144D	4 x 75 x 100	U-Shank	Fast and straight cutting, ideal for hardwood, softwood and laminated boards	3
20009503204	3104-XL 5	4 x 120 x 152	T-Shank	Ideal for straight, parallel cuts High-speed cuts in hardwood, softwoods and chipboard	5
20009505404	T244D	4 x 75 x 100	T-Shank	Fast curved cutting, ideal for hardwood, softwood and laminated boards	5
20009505504	T119BO	2 x 50 x 76	T-Shank	Especially for curved cutting, ideal for epoxy, hardwood, softwood, laminated boards, insulated and heat insulation materials and plastics	5
20009505604	T301CD	4 x 90 x 116	T-Shank	Clean and precise cutting, ideal for hardwood, softwood, laminated boards, fibre boards and plastics	5
20009503102	U301CD	3 x 90 x 116	U-Shank	Clean and precise cutting, ideal for hardwood, softwood, laminated boards, fibre boards and plastics	3
20009502302	U101AO	1.4 x 50 x 76	U-Shank	Clean and precise curved cutting, ideal for hardwood, softwood, laminated boards, fibre boards and plastics	3
20009505704	T101AO	1.4 x 50 x 76	T-Shank	Clean and precise curved cutting, ideal for hardwood, softwood, laminated boards, fibre boards and plastics	5
20009505804	T101BR	2.5 x 75 x 100	T-Shank	Clean and precise straight cutting, ideal for hardwood, softwood, laminated boards, fibre boards and plastics	5
20009503002	U101BR	2.5 x 75 x 100	U-Shank	Clean and precise straight cutting, ideal for hardwood, softwood, laminated boards, fibre boards and plastics	3
20009501100	T101BF	2.5 x 75 x 100	T-Shank	Clean and precise straight cutting, ideal for hardwood, softwood, laminated boards, fibre boards and plastics	1
20009505904	T311C	2.75 x 100 x 126	T-Shank	Clean and precise straight cutting, ideal for hardwood, softwood and laminated boards	5
20009506002	T225B	2.75 x 225 x 250	T-Shank	Clean and precise straight cutting, ideal for hardwood, softwood and laminated boards	3

JIG SAW BLADE SETS

Cat. №	Contents	Pcs/Pack
20009500714	① Set of one blade each: T101AO, T101BR, T101B. For wood.	3
20009501014	② Set of one blade each: T118G, T101B, T144D. For wood and metal.	3
20009500914	③ Set of one blade each: T111C, T101D, T119BO. For wood and metal.	3
20009500814	④ Set of one blade each: T101AO, T101BR, T101B, T101D/T118A. For wood and metal.	5
20009501101	⑤ Set of 2 T101BF	2





①

②

③

④

⑤

SABRE SAW BLADES

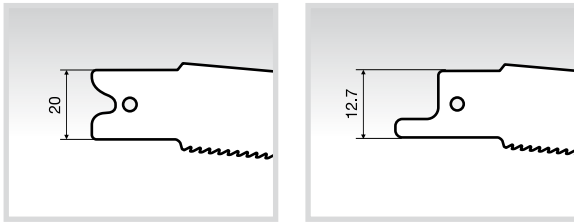

Cat. Ne	Cutting length, mm	Tooth space, mm	Thickness, mm	Fitting dimension, mm	Material	Purpose	Pcs/Pack
20009501301	140	2.5	0.95	20	BiM	Steel pipes	2
20009501401	140	3.2	0.95	20	BiM	Steel pipes	2
20009501501	200	3.2	0.95	20	BiM	Steel pipes	2
20009501601	150	1.8	0.95	20	BiM	Universal for metal, wood with nails, pallets etc.	2
20009501701	150	2.5	0.95	20	BiM	Universal for metal, wood with nails, pallets etc.	2
20009501801	300	1.8	0.95	20	BiM	Universal for metal, wood with nails, pallets etc.	2
20009501901	300	2.5	0.95	20	BiM	Universal for metal, wood with nails, pallets etc.	2
20009503401	140	2.5	0.9	12.7	BiM	For wood with nails, metal medium-thick	2
20009503501	140	1.8	0.9	12.7	BiM	Fast cutting for metal	2
20009503601	140	1.8	0.9	12.7	BiM	For metal sheets medium-thick 2-8 mm	2
20009502001	150	1.8	0.95	12.7	BiM	Metal	2
20009502101	150	2.5	0.95	12.7	BiM	Universal for metal, wood with nails, pallets etc.	2
20009503701	280	4.3	1.5	12.7	BiM	Fast cutting for wood with nails, pallets, epoxy	2
20009503801	220	5	1.5	12.7	HCS	Fast cutting in wood	2
20009502201	300	4	0.95	12.7	HCS	Wood	2
20009503900	240	2.3	1.5	12.7	HM/CT	For small bricks up to a material thickness of 150 mm	1
20009504000	305	5.0	1.5	12.7	HM/CT	For medium-sized bricks up to a material thickness of 215 mm	1

CIRCULAR SAW BLADES

Material: TCT

Cat. Ne	Type	Diameter, mm	Bore, mm	Number of teeth	Cutting width, mm	Pcs/Pack
Coarse cutting: for straight and cross cutting of softwood, hardwood and boards						
20009520000	T12	150	20	12	2.5	1
20009522200	T18	140	20	18	2.5	1
20009520100	T20	200	30	20	2.8	1
20009522900	T24	140	20	24	2.5	1
20009522300	T24	165	20	24	2.5	1
20009520200	T24	185	20	24	2.5	1
20009522600	T24	250	30	24	2.8	1
20009520300	T32	235	30	30	3.8	1
20009522500	T30	305	30	30	3.0	1
Fine cutting: for straight and cross cutting of hardwood, softwood, fibreboard, furniture boards, laminated boards and wood flooring						
20009523000	T36	140	20	36	2.5	1
20009520400	T36	150	20	36	2.5	1
20009523100	T36	165	20	36	2.5	1
20009520600	T36	185	20	36	2.5	1
20009520500	T36	200	30	36	2.7	1
20009521000	T48	235	30	48	2.4	1
20009520800	T48	305	30	48	3.0	1
Very fine cutting: for straight and cross cutting of hardwood, softwood, fibreboards, furniture boards, laminated boards and wood flooring						
20009523200	T48	165	20	48	2.5	1
20009521100	T48	185	20	48	2.4	1
20009521400	T48	200	30	48	2.7	1
20009522400	T48	210	30	48	2.5	1
20009522700	T48	250	30	48	2.8	1
20009521900	T60	235	30	60	2.4	1
20009521200	T60	250	30	60	2.8	1
20009522800	T60	305	30	60	3.0	1
Very clean cutting: for straight and cross cuttings of hardwood, softwood, fibreboards, furniture boards, laminated boards and wood flooring						
20009521500	T56	200	30	60	2.7	1
20009523300	T60	210	30	60	2.5	1
20009522800	T60	305	30	60	3.0	1
20009522000	T80	235	30	80	2.7	1
20009522100	T80	250	30	80	2.7	1
20009521600	T80	305	30	80	3.0	1
Ultra fine cutting in various materials: for cutting in plastics, aluminium, brass and copper						
20009521700	T100	250	30	100	2.8	1
20009521800	T100	305	30	100	3.0	1



VACUUM CLEANER ACCESSORIES



Cat. №	Description	Used with	Pcs/Pack
20009640200	① Cellulose pleated filter for dry vacuum cleaning	VC 1220, VC 1221	1
20009640900	② Cellulose pleated filter for dry vacuum cleaning	VC 1650MS	1
20009640300	③ Polyester pleated filter for dry vacuum cleaning	VC 1321MS, VC 1430MS, VC 1431MS	1
20009640800	④ Polyester pleated filter for wet and dry vacuum cleaning	VC 1650MS	1
20009640004	⑤ Dust bag 20 l, for dry vacuum cleaning	VC 1321MS, VC 1220, VC 1221	5
20009640104	⑥ Dust bag 30 l, for dry vacuum cleaning	VC 1430MS, VC 1431MS	5
20009641004	⑦ Standard dust bag 50 l, for dry vacuum cleaning	VC 1650MS	5
20009641302	⑧ Fine dust bag 30 l, for dry vacuum cleaning	VC 1321MS, VC 1430MS, VC 1431MS	3
20009641102	⑨ Fine dust bag 50 l, for dry vacuum cleaning	VC 1650MS	3
20009641202	⑩ HEPA B dust bag 50 l, for dry vacuum cleaning	VC 1650MS	3
20009640409	⑪ Foam filter for wet and dry vacuum cleaning	VC 1220, VC 1221, VC 1321MS, VC 1430MS, VC 1431MS, VC 1650MS	10
20009640502	⑫ Dry filter	VC 1220, VC 1221	3
20009640600	⑬ Power tool adapter Ø21/27/32/37/42 mm	VC 1220, VC 1221, VC 1430MS	1
20009643500	⑭ Extensible hose 5 m, Ø35 mm	VC 1430MS	1
20009644200	⑮ Extensible hose 2.5 m	VC 1430MS	1
20009641400	⑯ Telescopic tube	VC 1430MS, VC 1431MS	1
20009641500	⑰ Crevice nozzle	VC 1430MS	1
20009641600	⑱ Air control handle	VC 1430MS	1
20009641700	⑲ Combo brush	VC 1430MS	1
20009641814	⑳ Plastic tube set	VC 1220	1
20009641900	㉑ Floor nozzle	VC 1220	1
20009642401	㉒ Flat Filter, for dry and wet cleaning	VC 1530SA, VCM 1530SA	2
20009642500	㉓ PET cartridge filter, for dry and wet cleaning	VC 1530SP, VCM 1530SP	1
20009642204	㉔ Fleece filter bag, for dry cleaning only	VC 1530SP, VCM 1530SP	5
20009642304	㉕ Disposal bag, for dry cleaning only	VC 1530SA, VCM 1530SA	5
20009642000	㉖ AB 150 – attachment for pneumatic tools	VC 1530SP, VCM 1530SP, VC 1530SA, VC 1530SA	1

ROUTER BIT SET

Compatible with routers X 52E, X 75CE, X 105CE, X 150CE, X 205CE

Cat. №	Pcs/Pack
20009620014	12

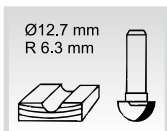
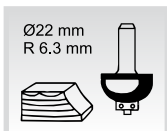
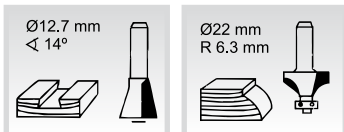

Ø8mm shaft

12 pcs. in package

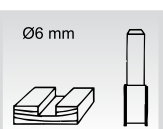
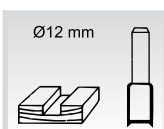
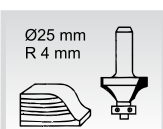
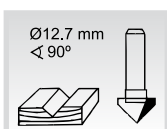
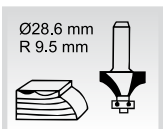
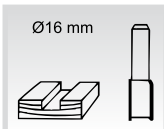
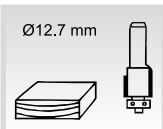
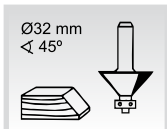

SAW HORSE – SD 2

- All-purpose stand for sawing with hand, motor and power saws
- Stable, sturdy galvanised steel section construction
- Space-saving storage
- Max. trunk diameter: 23 cm
- Max. trunk weight: 50 kg
- Operation height: 75 cm
- Weight: 8 kg
- Dimensions: 70x80x85 cm
- Transport package dimensions: 12x5.5x100 cm



Cat. №	Pcs/Pack
20009680000	1

MEASURING & DETECTION EQUIPMENT

LDD 60 – LASER DISTANCE METER ▶

- Measures distance, area and volume
- Memory function
- Stakes out equal distances
- Metric and imperial conversions
- Spirit level
- Large, easy-to-read LCD display with backlight
- Protective case
- Complete with 2 x 1.5V DC batteries



Cat. №	Pcs/Pack
20009860100	1

UDD 16 – ULTRASONIC DISTANCE DETECTOR ▶

- Ultrasonic distance detector with laser point
- Measures distance, area and volume
- Memory function
- Laser alignment
- Low battery indicator
- Metric and imperial conversions
- Spirit level
- Large, easy-to-read LCD display
- Protective case
- Complete with 1 x 9V DC battery



Cat. №	Pcs/Pack
20009860000	1

MFD 16 – MULTI-FUNCTION DETECTOR ▶

- Ultrasonic distance detector with laser point
- Calculation of distance, length, area and volume
- Detects metal
- Detects active circuit with AC 220V
- Detects wood
- Metric and imperial conversions
- Spirit level
- Low-battery indicator
- Large, easy-to-read LCD display with backlight
- Complete with 1 x 9V DC battery

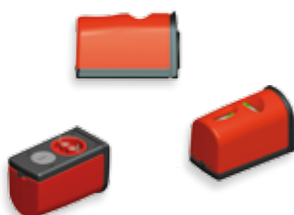

Cat. №	Pcs/Pack
20009860200	1



MEASURING TAPES

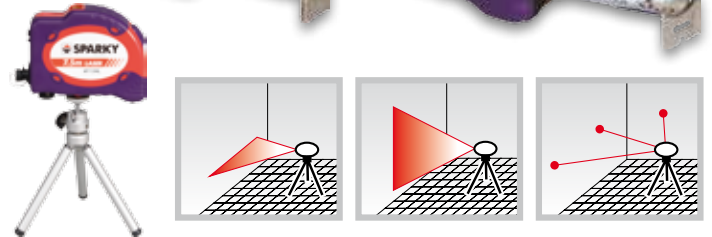

Cat. №	Type	Description	Pcs/Pack
20009700100	MT 5M	Tape length 5 m	1
20009709900	MT 7.5ML	Tape length 7.5 m, Laser level, c/w removable Tripod	1
20009709800	MT 10M	Tape length 10 m	1

STAPLES

Compatible with stapler T 14

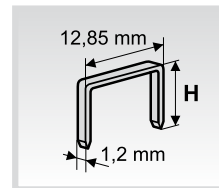

Cat. №	Type	Height, mm	Pcs/Pack
20009600013	851	6	1000
20009600113	851	8	1000
20009600213	851	10	1000
20009600313	851	12	1000
20009600413	851	14	1000

SCAFFOLD HOLDER / CLAMP

- For fixing SPARKCUT 106 to scaffold etc.

Cat. №	Pcs/Pack
20009683300	1

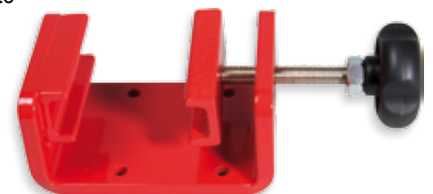

CUTTING WIRE

- Cutting wire for SPARKCUT 106 and 22/40
- Diameter 0.55 mm

Cat. №	Type	Pcs/Pack
20009683100	NiCr cutting wire, 10 m	1
20009683200	NiCr cutting wire, 30 m	1



CANTILEVER TOOL BOX



High quality cantilever metal tool box, powder coated in SPARKY Red



Cat. №	Type	Dimensions in cm	Pcs/Pack
20009708300	MWK 106	43 x 20 x 20, 5 trays	1
20009708400	MWK 205	53 x 20 x 20, 5 trays	1

BACKPACK



Cat. №	Description	Pcs/Pack
20009709600	① Backpack (35 l)	1
20009709700	② Notebook sleeve 15"	1
20009709514	③ Backpack & Notebook sleeve	1

CARRY BAG

- Fully protective carry bag
- Designed to hold fully assembled machine and accessories
- Internal and external pockets for storage
- Complete with shoulder strap



Cat. №	Pcs/Pack
20009685900	1

PADDED CARRY BAG

- Fully protective carry bag
- Designed to hold fully assembled machine and accessories
- Complete with shoulder strap

Cat. №	Used with	Pcs/Pack
20009708600	Medium reach Sanders SM(A) 712CE, SM 10	1
20009708500	Long reach Sanders SM(A) 717CE, SM 15	1



SPARKY BANNER

Advertising vinyl banner – 80 x 180 cm with mounting frame

Cat. №	Pcs/Pack
20009840000	1



SP 3 – DISPLAY

- One metre wide display stand
- Supplied with additional shelf and hooks
- Quick and easy to assemble
- Optional light canopy
- All steel construction
- Strong enough to hold most SPARKY machines

Cat. №	Pcs/Pack
20009840100	1



We reserve the right to make improvements or changes to our products without prior notice. This includes any obligation to make corresponding improvements or changes in products previously manufactured or sold.



SPARKY POWER TOOLS GmbH
 20, Leipziger Strasse
 10117 BERLIN, GERMANY
 Tel.: +49 30 203916-0
 Fax: +49 30 20391666
 e-mail: accessories@sparkygroup.com